

GOLDAIR



PLATINUM

HeatSmart Panel Heater



INVERTER
Energy Technology

Optimises the
wattage use to lower
your power bills!



WIFI
Enabled Controls

Easily control heating
and timing all from the
comfort of your armchair

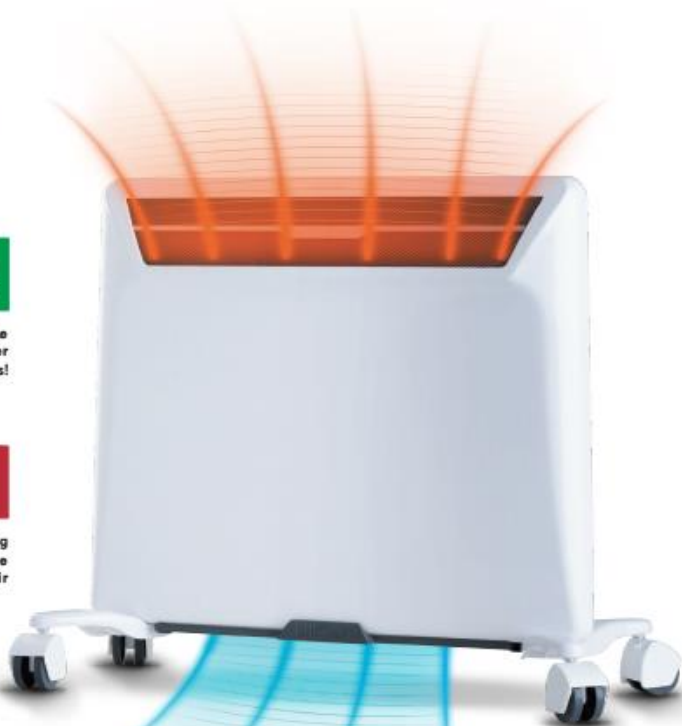

For Model: GPPH610, GPPH620, GPPH630

This page has been intentionally left blank.

General Care and Safety Guide

YOUR SAFETY IS IMPORTANT TO US. PLEASE ENSURE YOU TAKE NOTE OF THE INSTRUCTIONS AND WARNINGS OUTLINED IN THIS MANUAL.

CAUTION: In order to avoid a hazard due to inadvertent resetting of the thermal cut-out, this appliance must not be supplied through an external switching device, such as a timer, or connected to a circuit that is regularly switched on and off by the utility.

- This appliance is not intended for use by persons (including children) with reduced physical, sensory or mental capabilities or lack of experience and knowledge, unless they are supervised or have been given instruction concerning the use of the appliance by a person responsible for their safety.
- Children should be supervised to ensure that they do not play with the appliance.
- If the supply cord is damaged, it must be replaced by the manufacturer, its service agent or similarly qualified persons in order to avoid a hazard.

WARNING: You must not cover this heater. Covering this heater presents fire risk and will activate the safety fuse; permanently disabling the unit.

WARNING: Do not use this heater in small rooms when they are occupied by persons not capable of leaving the room on their own, unless constant supervision is provided.

WARNING: To reduce the risk of fire, keep textiles, curtains, or any flammable material a minimum distance of 1 metre from the air outlet.

WARNING: In order to avoid overheating or fire, do not cover the heater.

- The heater must not be located immediately below a socket outlet.
- Do not use the heater if it has been dropped or damaged.
- Do not use if there are visible signs of damage to the heater.
- Ensure heater is on a flat, stable, heat-resistant surface.
- Do not use this appliance in the immediate surrounds of a bath, a shower, or a swimming pool or other liquids.
- Keep all objects at least 1 metre from the front and 150mm from the sides of the appliance.
- This appliance is intended for household use only and not for commercial or industrial use.
- Indoor use only.
- Use only the voltage specified on the rating label of the appliance.
- Use this appliance only as described in this manual. Any other use is not recommended by the manufacturer and may cause fire, electric shock or injury.
- The common cause of overheating is deposits of dust or fluff in the appliance. Ensure these deposits are removed regularly by unplugging the appliance and vacuum cleaning the air vents and grills.

General Care and Safety Guide

- **Never use the appliance to dry clothes.**
- Always unplug appliance when not in use.
- Do not connect the appliance to mains supply until completely assembled and adjusted.
- Ensure hands are dry before handling the plug or main unit.
- Do not operate with cord set coiled up as a heat build up is likely, which could be sufficient to become a hazard.
- Carry out regular checks of the supply cord to ensure no damage is evident
- Do not operate this appliance with a damaged cord, plug or after the appliance malfunctions or has been dropped or damaged in any manner. Return to a qualified electrical person for examination, electrical service or repair.
- Do not twist, kink or wrap the cord around the appliance, as this may cause the insulation to weaken and split. Always ensure that all cord has been removed from any cord storage area and is unrolled before use.
- It is recommended that this heater is plugged directly into the wall socket. Power boards are not rated to supply power to high wattage appliances.
- A correctly specified, undamaged extension cord may be used with this heater provided it is used in a safe manner.
- Do not remove plug from power socket until the appliance has been switched off.
- Do not remove plug from power socket by pulling cord; always grip plug.
- Do not place cord under carpet or cover with rugs or furniture. Arrange the cord so it cannot be tripped over.
- Don't place appliance on bedding or on thick & long carpet where the openings may get blocked.
- Switch off and use handle provided when moving
- Do not place appliance close to radiant heat source.
- Do not insert or allow foreign objects to enter any ventilation or exhaust opening, as this may cause an electric shock, fire or damage to the appliance.
- Do not sit on the appliance.
- Do not use abrasive cleaning products on this appliance. Clean with a damp cloth (not wet) rinsed in hot soapy water only. Always remove plug from the mains supply before cleaning.
- Do not operate in areas where petrol, paint or other flammable liquids are used or stored.
- The appliance must not be immersed in any liquids.
- There are no user serviceable parts installed in the unit.
- Do not place the unit in wardrobes or other enclosed spaces as this may cause fire hazards.
- This unit is not supposed to be used in or around locations where foodstuffs, works of art or delicate articles of science, etc are stored.
- When the appliance has been unpacked, check it for transport damage and ensure all parts have been delivered. If parts are missing or the appliance has been damaged, contact the Customer Services Team.
- If your appliance does not work, or is not working properly, contact the place of purchase or the Customer Services Team.

Components

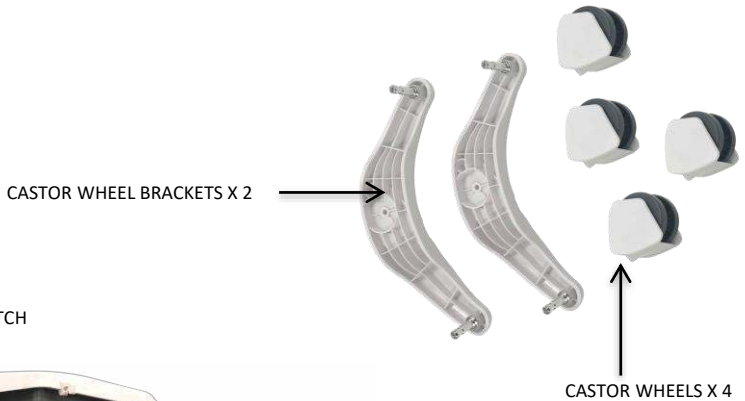
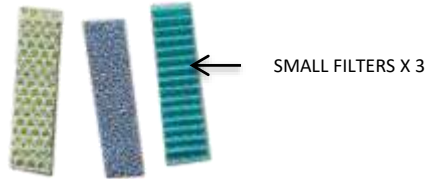
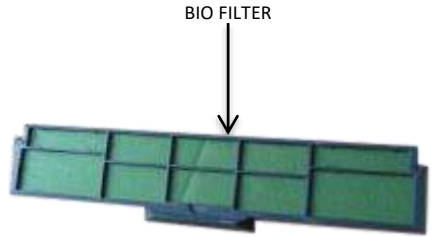

Assembly and Installation

Before using this appliance, it must either be wall mounted or have the castor plates and castors fitted. The screw pack to attach the feet to your appliance will be taped to either one of the feet for your appliance, or taped to the plug.

FREE STANDING

1. Ensure the appliance is unplugged and power switches are off.
2. Carefully turn the Main Body upside-down on a scratch-free and stable surface. Be careful to prevent damage to the cosmetic finish or your floor surfacing.
3. Firmly press Castor Wheels onto the posts on the Castor Wheel Bracket until they click into place. Some force may be required.
4. Align the screw hole on the Castor Wheel Bracket with the screw hole on the base of the appliance.
5. Attach Castor Wheel Bracket with the one way screws provided and ensure the bracket sits firmly in place (do not over tighten).
6. Return heater to the upright position.



Assembly and Installation

NOTE: Your Goldair Panel Heater should be installed with at least 150mm clearance from the floor and any other surrounding parts including other appliances, side walls, ceilings, shelves and soft furnishings.

WALL MOUNTED HEATERS ARE ONLY TO BE MOUNTED ON WALLS THAT COMPLY WITH CURRENT AS/NZS SPECIFICATIONS & BUILDING REGULATIONS

WALL MOUNTED

1. Make sure the heater is unplugged and power switches are off.
2. Position the panel heater within one metre of a wall socket. Do not mount in front of or below the wall socket. Ensure there is at least 150mm clearance from the floor and sides of the heater.
3. Detach the mounting bracket from the back of the panel appliance by unscrewing the two locking screws (located on the top of the mounting bracket).
4. Position the mounting bracket on the wall and mark the hole positions with a pen or pencil and check they are horizontal with a spirit level. Ensure the two bottom mount holes are at least 180mm from the floor and drill holes as required.
5. Secure the mounting bracket to the wall with the mounting screws. (For masonry walls use the plastic sheaths).
6. Slot the back of the appliance onto the mounting bracket locating the bottom plugs first and secure with two locking screws.
7. Plug appliance into a standard 240 volt AC electrical outlet.

Note: Do not run the power cord behind the heater.

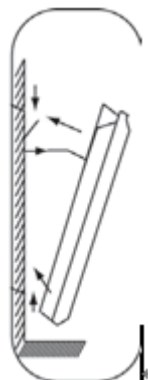
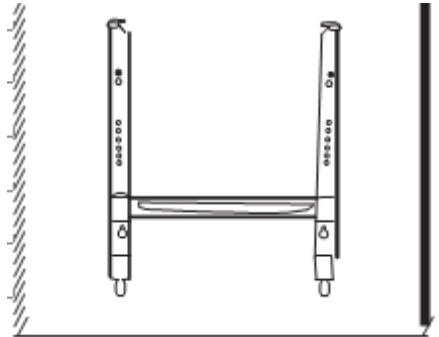
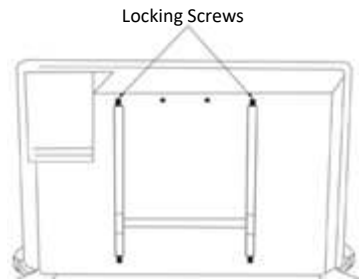

Operating Your Heater

Always choose a safe location for the appliance, keeping in mind the safety precautions outlined. Ensure all packaging has been removed from the unit before use. This appliance requires no installation, it should be used solely as a portable appliance.

WARNING: In order to avoid overheating or fire, do not cover the heater.

WARNING: Keep all objects at least 1 metre from the front and 150mm from the sides of the appliance.

WARNING: Do not use this heater with a programmer, separate timer, remote-control system or any other device that switches the heater on automatically, since a fire risk exists if the heater is covered or positioned incorrectly.

WARNING: Never leave this heater unattended when in use.

If mounted on castors, ensure heater is on a flat, stable, heat-resistant surface.

WALL MOUNTED HEATERS ARE ONLY TO BE MOUNTED ON WALLS THAT COMPLY WITH CURRENT AS/NZS SPECIFICATIONS & BUILDING REGULATIONS

Once the heater is in a safe operating position and all switches are in the off position, insert the power plug into the mains outlet.

CAUTION: Ensure the power cord is not tight because if pulled it may partially pull the plug from the socket. A partially inserted plug will overheat the plug and socket and could result in fire.

Operating Your Heater

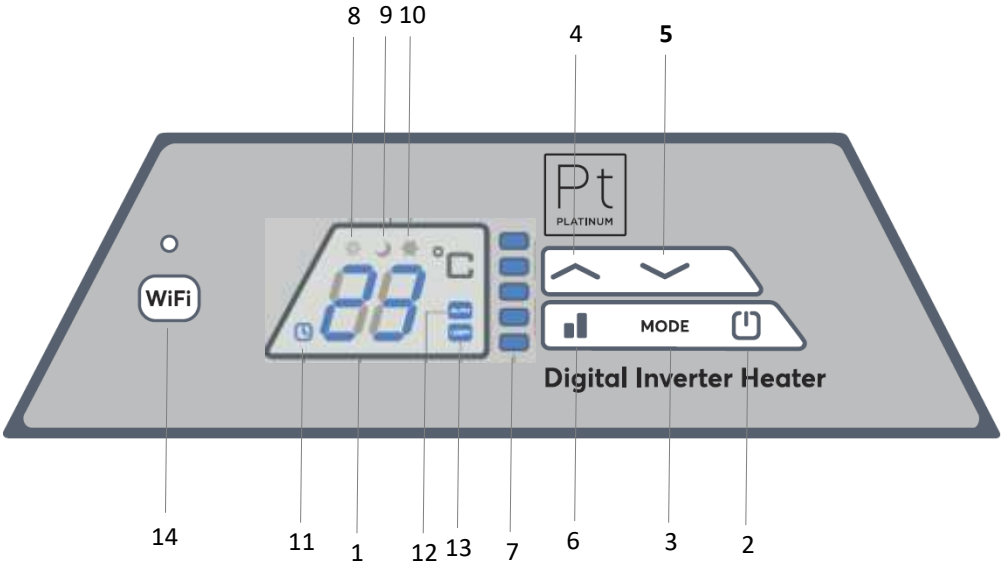

1. LED display
2. On/Off button
3. Mode setting button
4. Up button
5. Down button
6. Power setting button
7. Power indicator lights

8. Comfort indicator light
9. Economy indicator light
10. Anti-frost indicator light
11. Timer indicator light
12. Auto indicator light
13. User indicator light
14. WiFi button

Operating Your Heater



Check that the heater main power switch is in the OFF position before plugging into the mains supply. Turn the main power switch which is on the right hand side of the appliance just below the control panel to the "I" position to turn the heater on. The heater will beep once and will be stand by mode.



Press the  button. A beep will sound indicating the heater is now on and the setting will be "AUTO" mode. The current temperature will be displayed on the screen.

To turn the heater off, press the  button for at least 2 seconds until the heater switches off.

AUTO Mode

In "AUTO" mode you can set either Comfort or Economy settings as shown below. The default temperature setting is 25°C. Set your desired temperature by pressing the UP or DOWN   buttons. The screen will return to the current temperature after a few seconds but the set temperature will be retained unless changed by you.



Comfort mode can be set from 5 – 35°C





Economy mode can be set from 5 - 31°C (this is pre-set so there is always a 4°C difference between Comfort and Economy settings)

You may want to set the economy temperature to a much lower level than the comfort temperature and set the heater to economy when going to bed so that the room it is in stays warm but not as hot as you would have it if you were in the room.

The heater will automatically set the best heat setting to reach the temperature you have set and will adjust the heat setting to maintain the temperature you have set. The blue lights will show which heat setting is currently in use.

USER mode

Press the  button to change from AUTO to USER mode. The power setting will go to high (all blue lights illuminated). You can select the power setting you want. There are 5 levels. The blue lights will decrease with each push. When it reaches the bottom light (lowest heat setting) the heater will then go back into AUTO mode.

In "USER" mode you can set either Comfort or Economy settings as shown below. The default temperature setting is 25°C. Set your desired temperature by pressing the UP or DOWN   buttons. The screen will return to the current temperature after a few seconds but the set temperature will be retained unless changed by you.



Comfort mode can be set from 5 – 35°C



Economy mode can be set from 5 - 31°C (this is pre-set so there is always a 4°C difference between Comfort and Economy settings)

You may want to set the economy temperature to a much lower level than the comfort temperature and set the heater to economy when going to bed so that the room it is in stays warm but not as hot as you would have it if you were in the room.

You can set the heat setting to any of the 5 levels to heat the room. It is best to set it at the highest setting to initially heat up the room and then set to a lower level to maintain the setting. When the room reaches the set temperature, the element will turn off and not turn on again until the room temperature drops lower than the set temperature.

Operating Your Heater



ANTI-FROST mode.

The heater is fitted with an “anti-frost” mode which can be activated by pressing the MODE button until the symbol is illuminated. The heater will automatically come on if the temperature drops below 5 degrees.



Note the appliance has to be turned on for this function to work. To deactivate this mode press the MODE button again to go back to comfort or economy mode.

AUTO OFF TIMER

Set the timing function by pressing the  button twice in quick succession.

The TIMER symbol  will light and the screen starts flashing, use the UP or DOWN   buttons to set the desired turn off time (from 1 to 24 hours). Once the set time has elapsed the heater will turn off.

CHILD LOCK

To activate the child lock, press both the UP and DOWN   buttons together for 3 seconds and the heater will then display [] to show the lock is active. After 5 seconds the screen will return to showing the heater settings but none of the keys will work until the child lock is deactivated by pressing both the UP and DOWN buttons again for 3 seconds.

WiFi – Downloading and Setting up APP

For WiFi, the APP is supported only on 2.4GHz WiFi channels. Please ensure your phone is 2.4GHz capable.

WARNING: Using the APP outside of your home means you could turn the heater on whilst you are not home.

You should never leave your heater unattended when in use.

Download Goldair Heater mobile APP

- Open the APP Store or Google Play on your mobile phone.
- Open "Search" and enter "Goldair"
- Click "GET" and begin to download and install.

Once downloaded to your phone open the APP



Tap REGISTER near the bottom of the screen.

- Select your country code
- Enter your cellphone number
- Tap "Next"

You will then receive a text message with a verification code.

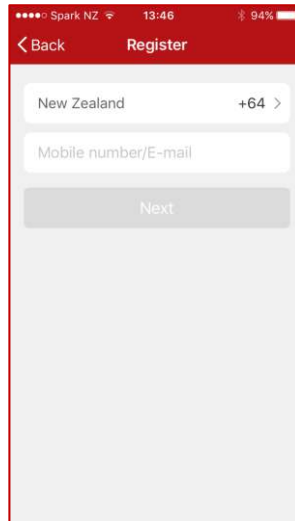
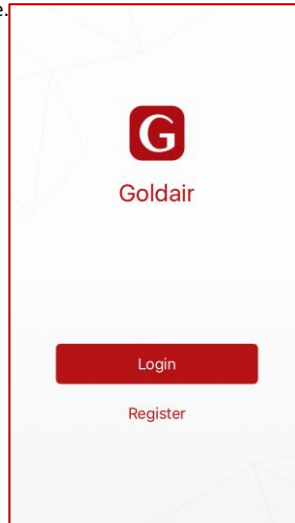

WiFi – Downloading and Setting up APP

- Enter the verification code from your text message
- Create a password.
- Then tap confirm.

If you haven't received a verification code via text message. Tap the resend button and when the verification code is received follow above steps.

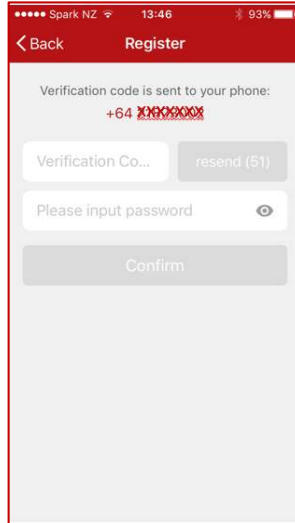

Your APP is now registered and ready for pairing to your heater.

Pairing APP to Heater

Turn the main power switch which is on the right hand side of the appliance just below the control panel to the “I” position to turn the heater on. The heater will beep once and will be stand by mode. Press the  button on the heater. A beep will sound indicating the heater is now on and the setting will be “AUTO” mode. The current temperature will be displayed on the screen.

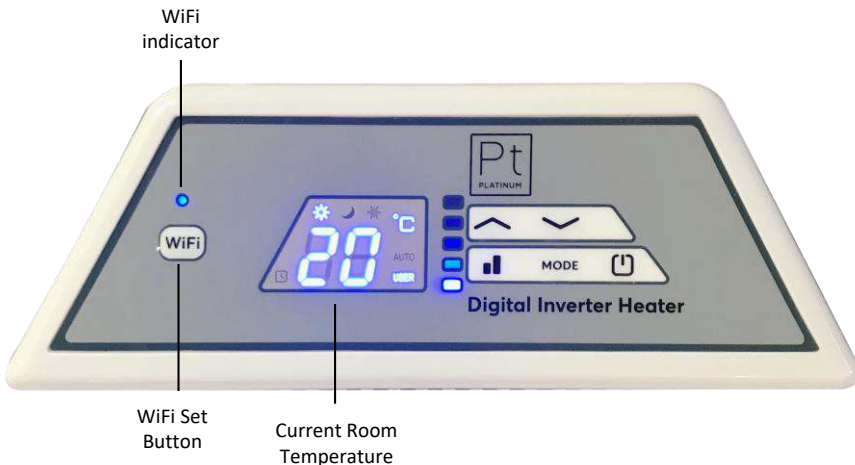

Pairing APP to Heater

On your phone tap “ADD DEVICE” to connect to the heater.

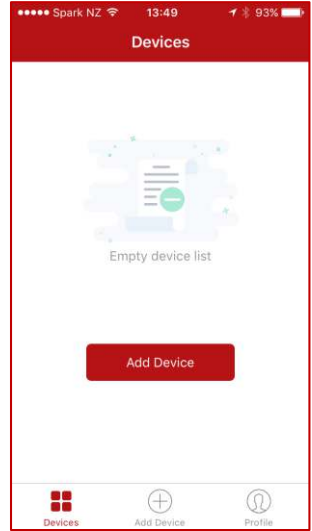

Press the “WiFi” button on the control panel of the heater for 5 seconds until the WiFi indicator light starts flashing.

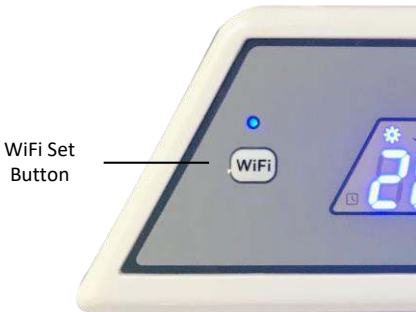

Tap ‘Next Step’ on the phone.

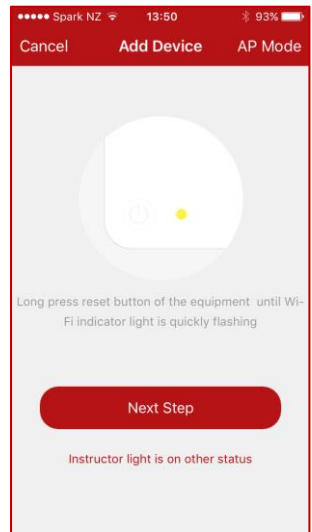

Pairing APP to Heater

Choose/confirm which WiFi to connect to.

Note: your phone may pick up other WiFi signals (e.g. neighbours) so you will need to choose.

Enter your WiFi password



The phone will then connect to the heater.

Ensure you have a good strong signal from your WiFi router.

Note: The WiFi indicator on the heater may go off during this pairing process.

Once complete the screen showing the device has been successfully added will appear.

Rename the heater if desired.

Tap "Done" to continue.

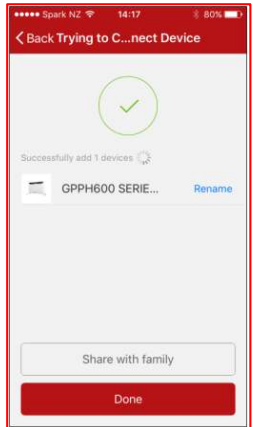
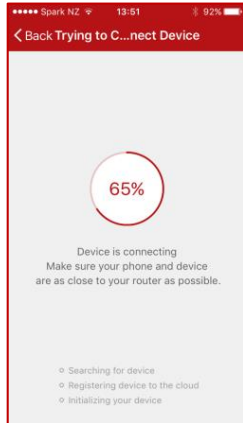

When the phone interface shows the addition is successful, and the WiFi indicator on the heater will stop flashing.

The heater pairing is complete and the main control screen on your phone will appear showing the heater as ON.



If the phone and heater fail to connect, then you will need to try to connect again as per the above process.

Operating your Heater from the APP

You can rename the heater.

Tap the 3 dots on the top right of the control screen of the APP to take you to the next page.

Click "Modify Device Name" and rename the heater.
Example: Bedroom 1, Dining Room etc. and tap save.

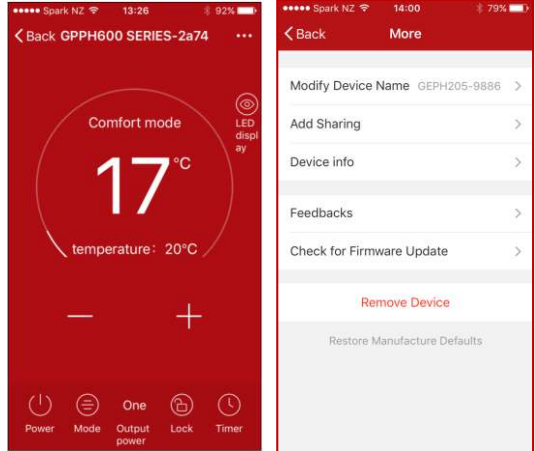

DEVICE SHARING SET UP

The person you add will need to have the Goldair Heater APP installed on their phone.

Open the "GOLDAIR APP" and tap the 3 dots in the top right of the screen.

Tap "Add Sharing" to enter the number of the person you want to include or tap the phone icon to select the persons phone number.
Tap "Confirm" to complete the addition.

DEVICE SHARING CANCELLATION

Open the "GOLDAIR APP" and tap the 3 dots in the top right of the screen. Tap "Add Sharing" and delete the phone numbers of shared members to cancel the device sharing.

NOTE: There can only be one user operating the heater at a time. The APP needs to be closed on all other devices to enable the sharing to work.

NOTE: If someone else sets up their phone on the same heater without using the "Device Sharing" the original phone will be disconnected and the heater will disappear from the device list.

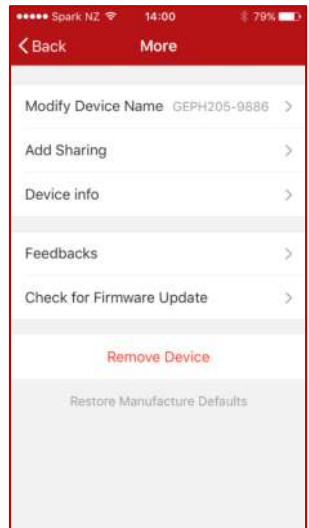

Operating your Heater from the APP

Mobile phone remote operation (connect heater power and turn on the side switch, so that the heater is in standby mode).

Open the "GOLDAIR" APP to select the heater (when using one mobile phone to control multiple heaters, you need to select the heater to be operated).

- Select the heater to be operated and enter the operation interface.

If the phone interface color is dark red, this indicates that the heater is in the OFF standby setting.

- Tap the OFF icon and the heater will turn on.
- The display will change to bright red.**
- You can now control the heater.
 - To turn the heater off again tap the power icon and the heater will revert to the dark screen.



Dark Red – Heater Off



Bright Red – Heater On

TEMPERATURE SETTING:

- Tap the "+" or "-" button to set the temperature.
- When the set temperature is higher than the ambient temperature, the heater begins to heat.
- If the heater temperature setting is below ambient temperature the heater will be in standby mode and will not operate until the ambient temperature drops below the set temperature.

Depending on which mode you are in you can set the temperature as below.

Comfort mode can be set from 5 – 35°C

Economy mode can be set from 5 - 31°C

(this is pre-set so there is always a 4°C difference between Comfort and Economy settings)



LED Display Icon

Tap this icon to turn off the LED display on the heater. This does not affect the operation of the heater.

To turn the heater display back on, tap the icon again



Operating your Heater from the APP

MODE

Mode can be set to Comfort, Eco or Anti-frost.

Set your desired temperature in Comfort or Eco modes by pressing "+" or "-" buttons.

The screen will display which mode has been selected and the current set temperature and ambient temperature.

Comfort mode can be set from 5 – 35°C

Economy mode can be set from 5 - 31°C

(this is pre-set so there is always a 4°C difference between Comfort and Economy settings)

Anti-frost mode is pre-set at 5°C and cannot be adjusted.



HEAT SETTINGS

In USER, you can set the heat settings from ONE (lowest) to FIVE (highest) and the set level will be shown on the bottom of the APP.

It will also show on the heater display.

In AUTO, the heater will adjust the heat settings automatically to suit the amount of power required to reach and then maintain the set temperature.

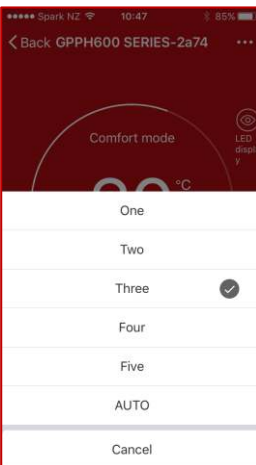



CHILD LOCK

Tap the padlock icon to display the closed padlock and "ON", indicating that the child lock is active.

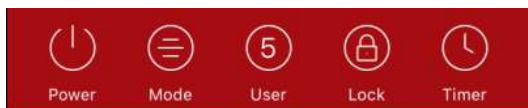
Tap the padlock icon again to unlock the child lock. You can adjust the heater settings with your mobile phone without having to unlock the child lock.



If you want to adjust the heater using the heater controls then you must first press the heaters press both the UP and DOWN buttons together for 3 seconds or tap the padlock button on t   lock it.



AUTO OFF TIMER

When the heater is ON you can set it to turn OFF after a number of hours (1-24 hours) has elapsed.

- In the APP, tap the heater to be operated and enter the operation interface.
- With the power icon on the lower left corner of the mobile phone interface is displaying ON and the heater is turned ON.
- Tap the timer button and scroll to select the number of hours before the heater will turn OFF and tap OK to return to the heater operation interface.
- The timer icon on the lower right will display how long before the timer will turn the heater OFF.

To cancel the timer, touch the timer button again and the numbers will disappear and just show timer.

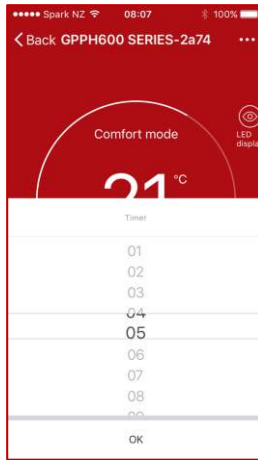

Adding Additional Heaters

From the “Devices” page of the APP press “Add Device” and follow the steps below to pair the new heater.

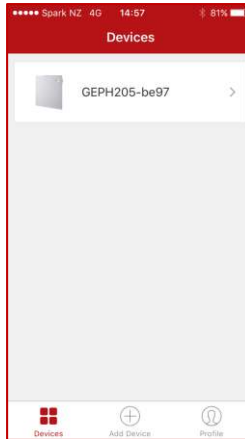

Choose/confirm which WiFi to connect to.
Note: your phone may pick up other WiFi signals (eg. neighbours) so you will need to choose.



Enter your WiFi password

Adding Additional Heaters

The phone will then connect to the heater.
Ensure you have a good strong signal from your WiFi router.

Note: The WiFi indicator on the heater screen may disappear during this pairing process.

Once complete the screen showing the device has been successfully added will appear.

Rename the heater if desired.

Tap "Done" to continue.

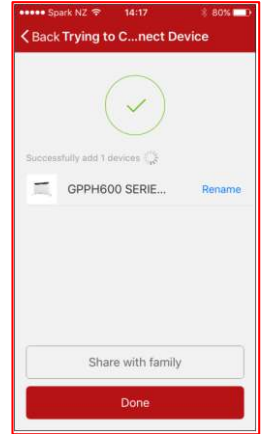

Your Devices list will then show the additional heaters that you have paired

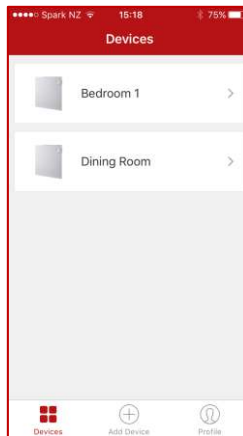

Troubleshooting

Please refer to the Goldair website

<http://www.goldair.co.nz/product-catalogue/heating/wifi-heaters>

Or free phone 0800 232 633 (NZ Only)

<http://www.goldair.com.au/product-catalogue/heating/panel-heaters>

Or free phone 1300 GOLDAIR (1300 465 324) (Australia Only)

Care and Cleaning



BIO FILTER

Blue/Grey

Activated Carbon Filter

Deodorises air and absorbs unpleasant smells



Green

Catechin Filter

Catechin is a natural anti-bacterial substance derived from tea leaves that kills germs



Yellow

Vitamin C Filter

fills the air with vitamin C which helps to reduce stress and has therapeutic benefits

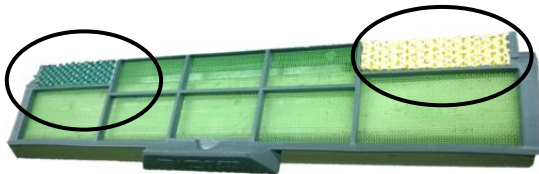

Place the small filters on the large filter as shown below. You can choose any combination but you can only use two of the additional filters at a time.

- The heater requires regular cleaning to ensure trouble free operation:
- Unplug the heater from the mains supply before cleaning.
- Ensure that the heater has been allowed to cool down completely before cleaning.
- The common cause of overheating is deposits of dust or fluff in the appliance. Ensure these deposits are removed regularly by unplugging the appliance and vacuum cleaning the air vents and grills.
- Use a damp cloth (not wet) to wipe the exterior of the heater to remove dust and dirt.
- Never use solutions such as petrol, thinners or polishing agents.
- Ensure the heater is dry before plugging back into the mains supply.

Operating Your Heater

SAFETY DEVICES

This appliance has three protection devices:

- Tilt Switch - this will automatically turn the appliance off if the appliance is not in the correct operating position.
- Resettable Thermal Link - this will automatically disconnect the power to the appliance at a pre-set overheat temperature. After cooling down it will reset and power on again. If this occurs, investigate what is causing the appliance to overheat.
- Thermal Fuse - this disconnects the appliance permanently in case of overheating. (It is non resettable).

Note: The light in the power switch will remain on even after the safety devices have activated to show there is still power to the heater

CAUTION: The heater generates heat during use. Proper precautions must be taken to prevent the risk of burns, scalds, fires or other damage to persons.

PROOF OF PURCHASE

To receive warranty retain receipt as proof of purchase.

TECHNICAL SPECIFICATION

Model No: GPPH610, GPPH620, GPPH630
Supply: 220-240VAC 50Hz
Wattage: 900-1000W, 1350-1500W, 1800-2000W

GOLDAIR

SUPPORT AND TECHNICAL ADVICE

Goldair – New Zealand
Monday – Friday 8am-5pm
Phone +64 (0)9 917 4000
Phone 0800 232 633
info@cdb.co.nz

Goldair – Australia
Monday – Friday 8am-5pm
Phone +61 (0)3 9365 5100
Phone 1300 465 324
info@cdbgolair.com.au

Three Year Warranty

Thank you for purchasing this Goldair Platinum product. Your product is warranted against faults and manufacture when used in normal domestic use for a period of **three years**. In non-domestic use Goldair limits the voluntary warranty to **three months**.

Goldair undertake to repair or replace this product at no charge if found to be defective due to a manufacturing fault during the warranty period.

This warranty excludes damage caused by misuse, neglect, shipping accident, incorrect installation, or work carried out by anyone other than a qualified electrical service technician.

PLEASE KEEP YOUR RECEIPT AS THIS WILL HELP VERIFY YOUR WARRANTY.

The benefits given to you by this warranty are in addition to other rights and remedies available to you under law in relation to the goods or services to which this warranty relates.

In Australia, our goods come with guarantees that cannot be excluded under the Australian Consumer Law. You are entitled to a replacement or refund for a major failure and compensation for any other reasonably foreseeable loss or damage. You are also entitled to have the goods repaired or replaced if the goods fail to be of acceptable quality and the failure does not amount to a major failure.

In New Zealand this warranty is additional to the conditions and guarantees of the Consumers Guarantee Act (1993).

Goldair – New Zealand

CDB Goldair
PO Box 100-707
N.S.M.C
Auckland

Phone +64 (0)9 917 4000
Phone 0800 232 633
www.goldair.co.nz

Goldair – Australia

CDB Goldair Australia Pty
PO Box 574
South Morang
Victoria, 3752

Phone +61 (0)3 9365 5100
Phone 1300 GOLDAIR (1300 465 324)
www.goldair.com.au

Goldair Three Year Warranty (IMPORTANT: Please complete and retain this warranty card)

Name _____

Address _____

Place Of Purchase _____ Date Of Purchase _____

Name Of Product _____ Model Number _____

Attach a copy of the purchase receipt to this warranty card

GOLDAIR



P L A T I N U M

Goldair Platinum Series

At Goldair we have been developing heaters for more than 30 years. We are proud of the Platinum Series, which represents key models in specific heating categories. Goldair Platinum models are designed to complement modern home décor with minimalistic design and clean lines still while delivering both functionality and performance.

Designed with you in mind

Goldair is committed to meeting all appropriate AS/NZS safety standards and we conduct a rigorous regime of both internal and external testing for all relevant products. This includes testing in our own laboratory facilities as well as by internationally recognised independent labs. Your Goldair Platinum purchase is backed by a 3 Year Warranty.

Love your Goldair

For more than 30 years, Goldair has been the leading name behind products that people love and trust in their homes. From heaters that will warm your heart, to coloured kettles and toasters to keep your kitchen looking cool, and BBQs that will get your summer sizzling – Goldair's got it all.

CDB  GOLDAIR

New Zealand

PO Box 100707
North Shore Mail Centre
Auckland 0745
www.goldair.co.nz

Australia

PO Box 574
South Morang
Victoria 3752
www.goldair.com.au