

User's Manual



■ Features

- Constant Current mode output
- Plastic housing with Class II design
- Built-in active PFC function
- Class 2 power unit
- IP67 rating for indoor or outdoor installations
- Function: 3 in 1 dimming
- Typical lifetime >50000 hours
- 5 years warranty

■ Applications

- LED panel lighting
- LED downlight
- LED decorative lighting
- LED tunnel lighting
- Moving sign

■ GTIN CODE

MW Search: <https://www.meanwell.com/serviceGTIN.aspx>

■ Description

LPF-25D series is a 25W AC/DC LED driver featuring the constant current output. LPF-25D operates from 90~305VAC and offers models with different rated voltage ranging between 12V and 54V. Thanks to the efficiency up to 86%, with the fanless design, the entire series is able to operate for -35°C ~ +70°C case temperature under free air convection. The entire series is rated with IP67 ingress protection level and is suitable to work for a variety of applications at dry, damp or wet locations. LPF-25D is equipped with the 3 in 1 dimming function so as to provide the design flexibility for LED lighting system.

■ Model Encoding

LPF - 25D - 30

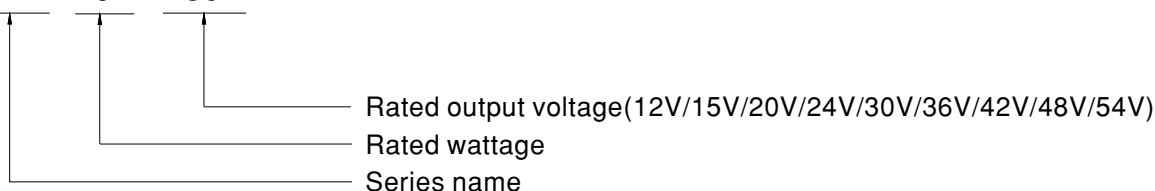



25W Constant Current Mode LED Driver

LPF-25D series

SPECIFICATION

MODEL	LPF-25D-12	LPF-25D-15	LPF-25D-20	LPF-25D-24	LPF-25D-30	LPF-25D-36	LPF-25D-42	LPF-25D-48	LPF-25D-54		
OUTPUT	DC VOLTAGE	12V	15V	20V	24V	30V	36V	42V	48V	54V	
	RATED CURRENT	2.1A	1.67A	1.25A	1.05A	0.84A	0.7A	0.6A	0.53A	0.47A	
	RATED POWER <small>Note.5</small>	25.2W	25.05W	25W	25.2W	25.2W	25.2W	25.2W	25.44W	25.38W	
	CONSTANT CURRENT REGION <small>Note.2</small>	6.6 ~ 12V	8.25 ~ 15V	11 ~ 20V	13.2 ~ 24V	16.5 ~ 30V	19.8 ~ 36V	23.1 ~ 42V	26.4 ~ 48V	29.7 ~ 54V	
	CURRENT RIPPLE	5.0% max. @rated current									
	CURRENT TOLERANCE	±5.0%									
	SETUP, RISE TIME <small>Note.6</small>	1500ms, 80ms / 115VAC 500ms, 80ms / 230VAC									
	HOLD UP TIME (Typ.)	16ms/230VAC 16ms/115VAC									
INPUT	VOLTAGE RANGE <small>Note.5</small>	90 ~ 305VAC 127 ~ 431VDC (Please refer to "STATIC CHARACTERISTIC" section)									
	FREQUENCY RANGE	47 ~ 63Hz									
	POWER FACTOR	PF ≥ 0.97/115VAC, PF ≥ 0.95/230VAC, PF ≥ 0.92/277VAC@full load (Please refer to "POWER FACTOR (PF) CHARACTERISTIC" section)									
	TOTAL HARMONIC DISTORTION	THD < 20% (@load ≥ 60%/115VAC, 230VAC; @load ≥ 75%/277VAC) (Please refer to "TOTAL HARMONIC DISTORTION (THD)" section)									
	EFFICIENCY (Typ.)	84%	84%	85%	85.5%	85.5%	85.5%	85.5%	86%	86%	
	AC CURRENT	0.4A / 115VAC 0.25A / 230VAC 0.2A/277VAC									
	INRUSH CURRENT(Typ.)	COLD START 50A(twidth=200µs measured at 50% Ipeak) at 230VAC; Per NEMA 410									
	MAX. No. of PSUs on 16A CIRCUIT BREAKER	12 units (circuit breaker of type B) / 21 units (circuit breaker of type C) at 230VAC									
LEAKAGE CURRENT	<0.75mA / 240VAC										
PROTECTION	OVER CURRENT	95 ~ 108% Constant current limiting, recovers automatically after fault condition is removed									
	SHORT CIRCUIT	Hiccup mode, recovers automatically after fault condition is removed.									
	OVER VOLTAGE	15 ~ 18V	17.5 ~ 21V	23 ~ 27V	28 ~ 35V	34 ~ 40V	41 ~ 49V	46 ~ 54V	54 ~ 63V	59 ~ 66V	
	OVER TEMPERATURE	Shut down o/p voltage, recovers automatically after temperature goes down									
ENVIRONMENT	WORKING TEMP.	Tcase=-35 ~ +70°C (Please refer to " OUTPUT LOAD vs TEMPERATURE" section)									
	MAX. CASE TEMP.	Tcase=+70°C									
	WORKING HUMIDITY	20 ~ 95% RH non-condensing									
	STORAGE TEMP., HUMIDITY	-40 ~ +80°C, 10 ~ 95% RH									
	TEMP. COEFFICIENT	±0.03%/°C (0 ~ 50°C)									
	VIBRATION	10 ~ 500Hz, 5G 12min./1cycle, period for 72min. each along X, Y, Z axes									
SAFETY & EMC	SAFETY STANDARDS <small>Note.8</small>	UL8750, CSA C22.2 No. 250.0-08, ENEC BS EN/EN61347-1, BS EN/EN61347-2-13 independent, BS EN/EN62384, EAC TP TC 004, GB19510.1, GB19510.14, IP67 approved ; Design refer to UL60950-1									
	WITHSTAND VOLTAGE	I/P-O/P:3.75KVAC									
	ISOLATION RESISTANCE	I/P-O/P:100M Ohms / 500VDC / 25°C / 70% RH									
	EMC EMISSION <small>Note.8</small>	Compliance to BS EN/EN55015, BS EN/EN61000-3-2 Class C (@load ≥ 55%) ; BS EN/EN61000-3-3, GB17743 and GB17625.1, EAC TP TC 020									
EMC IMMUNITY	Compliance to BS EN/EN61000-4-2, 3, 4, 5, 6, 8, 11; BS EN/EN61547, light industry level (surge immunity Line-Line 2KV), EAC TP TC 020										
OTHERS	MTBF	3574.2K hrs min. Telcordia SR-332 (Bellcore) ; 391.6Khrs min. MIL-HDBK-217F (25°C)									
	DIMENSION	148*40*32mm (L*W*H)									
	PACKING	0.36Kg; 40pcs/ 15.4Kg/1.02CUFT									
NOTE	<p>1. All parameters NOT specially mentioned are measured at 230VAC input, rated current and 25°C of ambient temperature.</p> <p>2. Please refer to "DRIVING METHODS OF LED MODULE".</p> <p>3. Ripple & noise are measured at 20MHz of bandwidth by using a 12" twisted pair-wire terminated with a 0.1uf & 47uf parallel capacitor.</p> <p>4. Tolerance : includes set up tolerance, line regulation and load regulation.</p> <p>5. De-rating may be needed under low input voltages. Please refer to "STATIC CHARACTERISTIC" sections for details.</p> <p>6. Length of set up time is measured at first cold start. Turning ON/OFF the driver may lead to increase of the set up time.</p> <p>7. The driver is considered as a component that will be operated in combination with final equipment. Since EMC performance will be affected by the complete installation, the final equipment manufacturers must re-qualify EMC Directive on the complete installation again.</p> <p>8. To fulfill requirements of the latest ErP regulation for lighting fixtures, this LED driver can only be used behind a switch without permanently connected to the mains.</p> <p>9. This series meets the typical life expectancy of >50,000 hours of operation when Tcase, particularly (Tc) point (or TMP, per DLC), is about 70°C or less.</p> <p>10. Please refer to the warranty statement on MEAN WELL's website at http://www.meanwell.com</p> <p>11. The ambient temperature derating of 3.5°C/1000m with fanless models and of 5°C/1000m with fan models for operating altitude higher than 2000m(6500ft).</p> <p>12. For any application note and IP water proof function installation caution, please refer our user manual before using. https://www.meanwell.com/Upload/PDF/LED_EN.pdf</p> <p>※ Product Liability Disclaimer : For detailed information, please refer to https://www.meanwell.com/serviceDisclaimer.aspx</p>										

■ BLOCK DIAGRAM

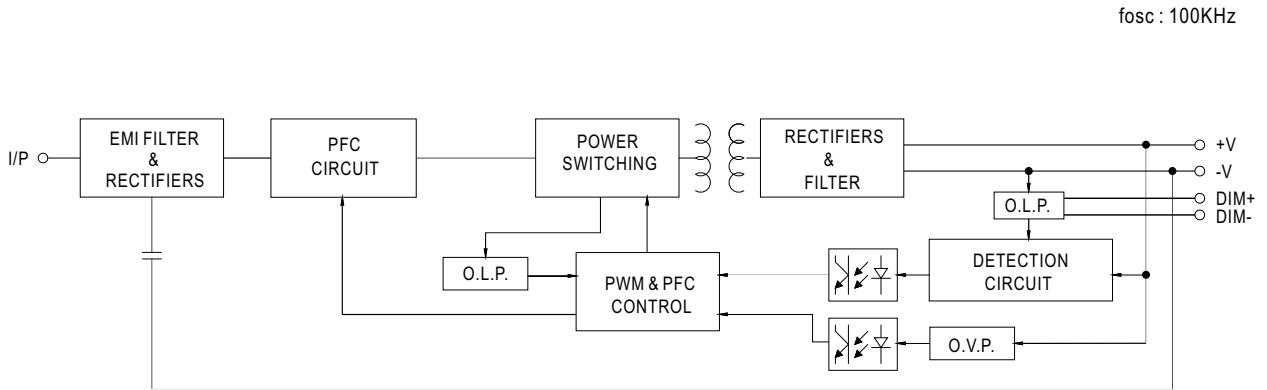

■ DRIVING METHODS OF LED MODULE

※ This series works in constant current mode to directly drive the LEDs.

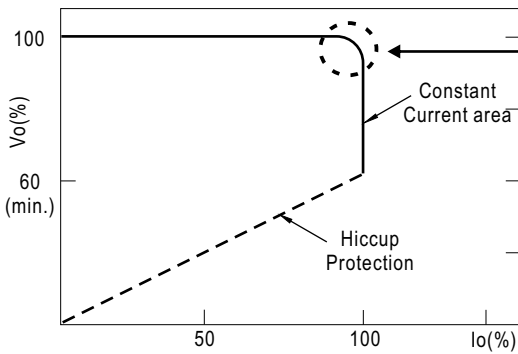

Typical output current normalized by rated current (%)

In the constant current region, the highest voltage at the output of the driver depends on the configuration of the end systems.
Should there be any compatibility issues, please contact MEAN WELL.

■ DIMMING OPERATION

※ 3 in 1 dimming function

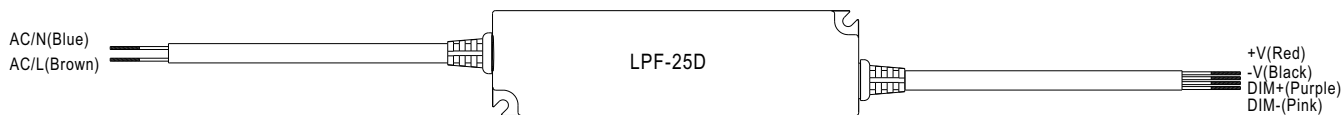

- Output constant current level can be adjusted by applying one of the three methodologies between DIM+ and DIM-: 1 ~ 10VDC, or 10V PWM signal or resistance.
- Direct connecting to LEDs is suggested. It is not suitable to be used with additional drivers.
- Dimming source current from power supply: 100 μ A (typ.)

◎ Applying additive 1 ~ 10VDC

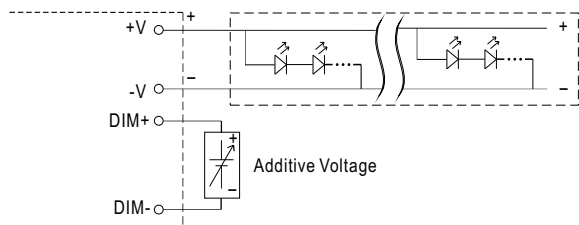

"DO NOT connect "DIM- to -V"

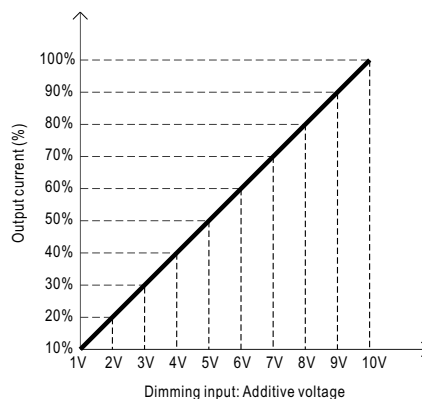

◎ Applying additive 10V PWM signal (frequency range 100Hz ~ 3KHz):

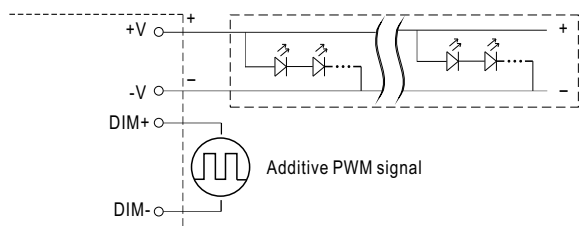

"DO NOT connect "DIM- to -V"

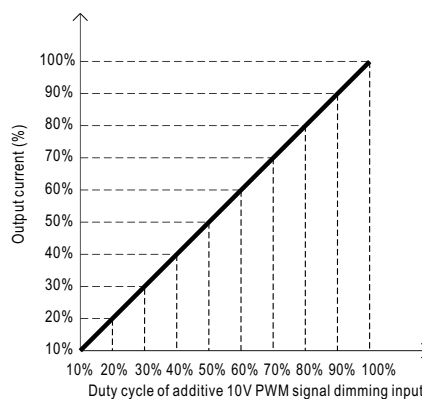

◎ Applying additive resistance:

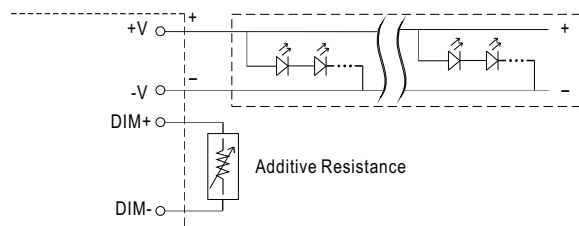

"DO NOT connect "DIM- to -V"

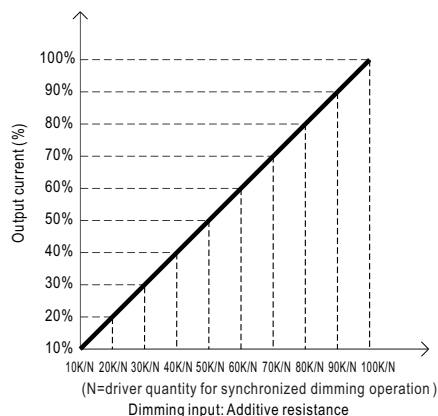

Note: In the case of turning the lighting fixture down to 0% brightness, please refer to the configuration as follow, or please contact MEAN WELL for other options.

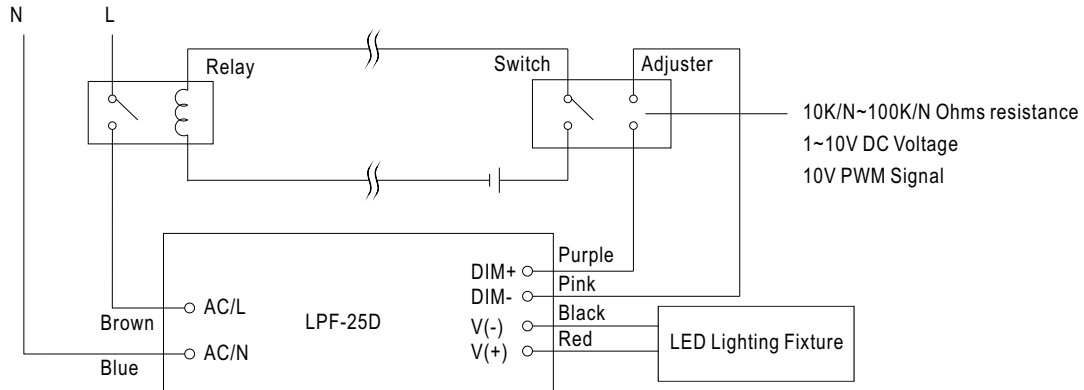

Using a switch and relay can turn ON/OFF the lighting fixture.

OUTPUT LOAD vs TEMPERATURE

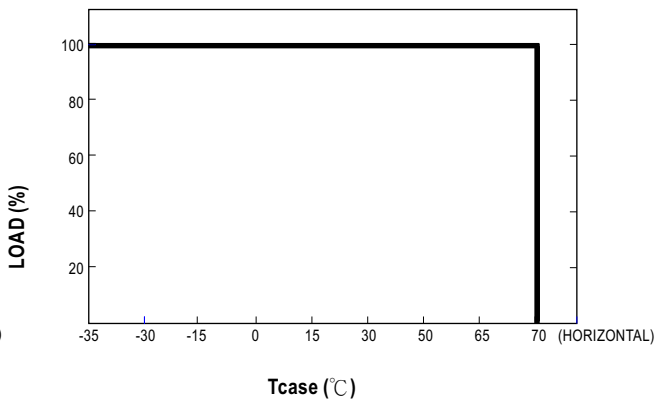
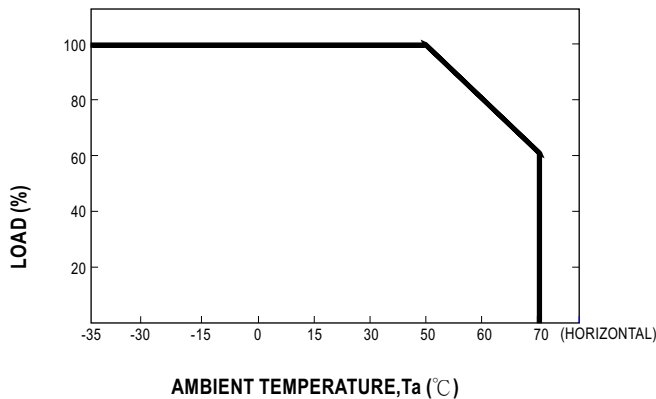

STATIC CHARACTERISTIC

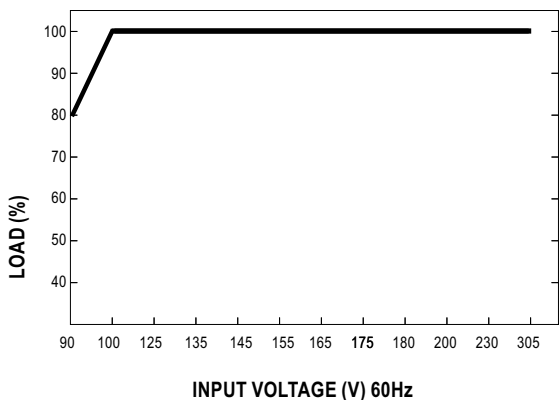

※ De-rating is needed under low input voltage.

POWER FACTOR (PF) CHARACTERISTIC

※ T_{case} at 60°C

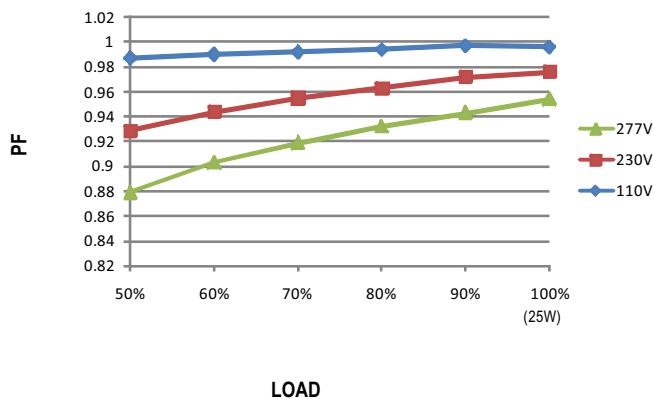

TOTAL HARMONIC DISTORTION (THD)

※ 48V Model, T_{case} at 60°C

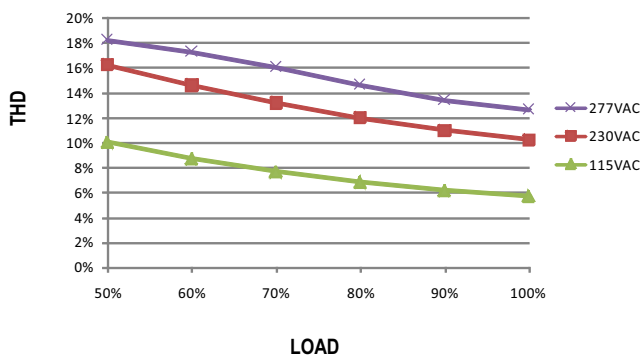

EFFICIENCY vs LOAD

LPF-25D series possess superior working efficiency that up to 86% can be reached in field applications.

※ 48V Model, T_{case} at 60°C

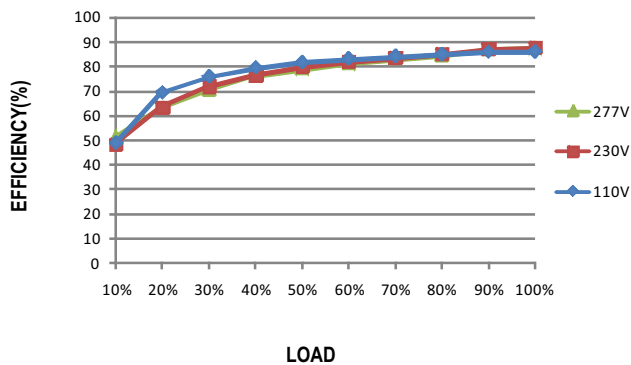

■ LIFE TIME

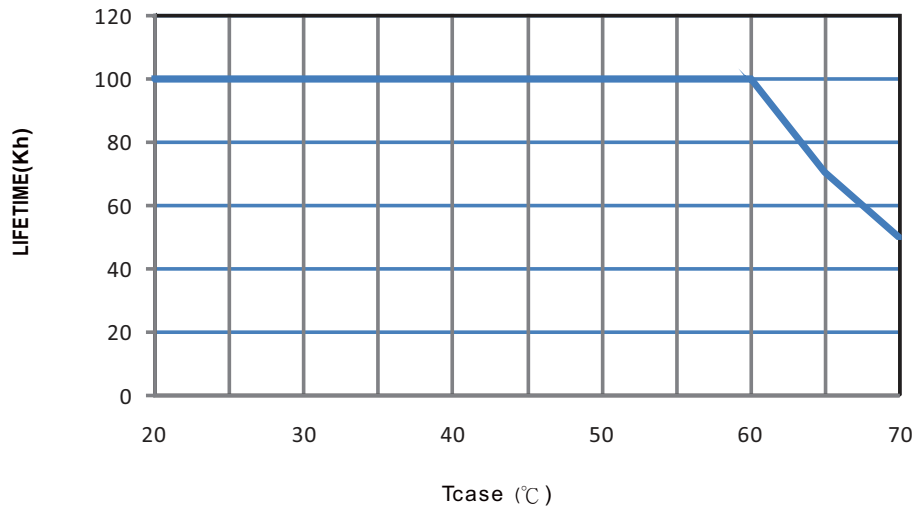

MECHANICAL SPECIFICATION

CASE NO.: LPF-16A Unit:mm

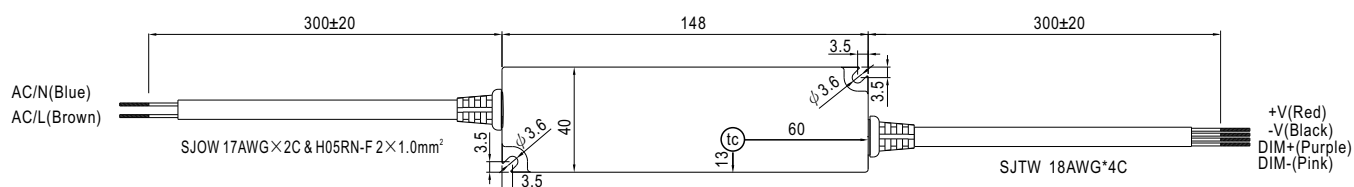

• (tc) : Max. Case Temperature



Recommend Mounting Direction

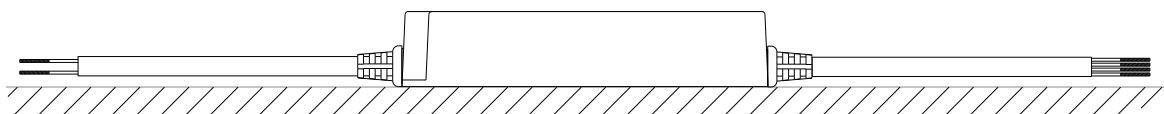

INSTALLATION MANUAL

Please refer to : <http://www.meanwell.com/manual.html>